

Name: \_\_\_\_\_

**A** Look and label the pictures with words from the box.

eraser pen ruler

1

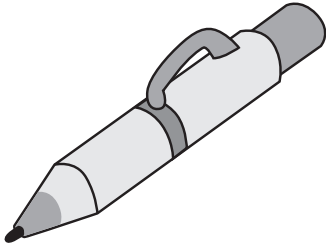

\_\_\_\_\_

-----

\_\_\_\_\_

2

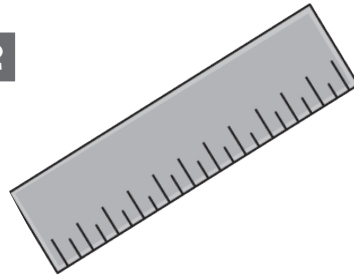

\_\_\_\_\_

-----

\_\_\_\_\_

3

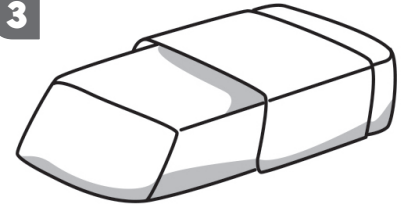

\_\_\_\_\_

-----

\_\_\_\_\_

**B** Look, read, and trace the correct word to complete the sentences.

1.

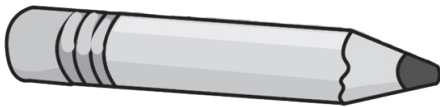

It's a pencil / pen.

2.

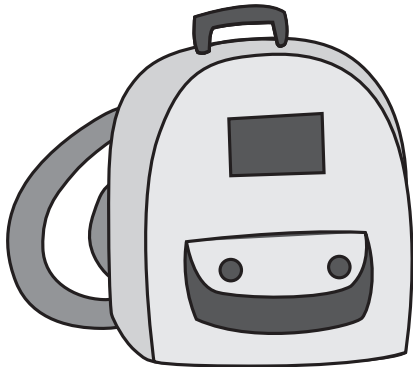

It's a ruler / backpack.

3.

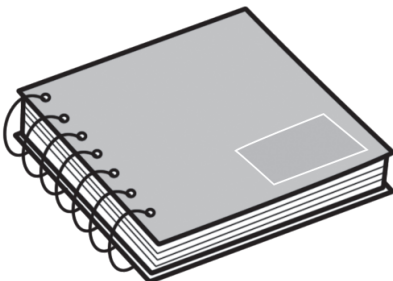

It's a notebook / eraser.

Name: \_\_\_\_\_

**A** Match the pictures with the words.

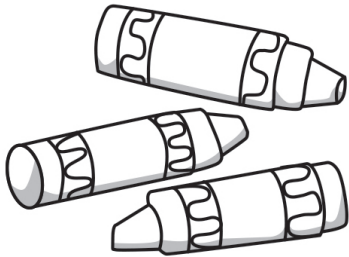

books

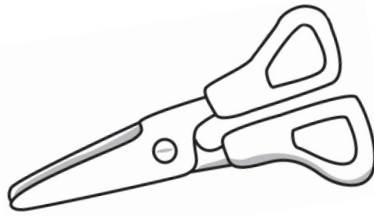

crayons

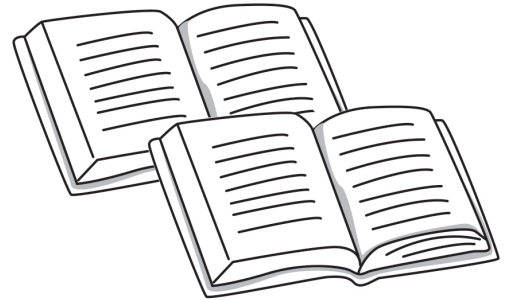

scissors



● Trace the words.

**B** Write the correct words to complete the sentences.

rulers erasers pens

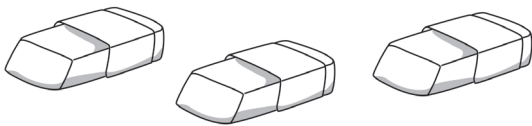

1. They're

\_\_\_\_\_

-----

\_\_\_\_\_

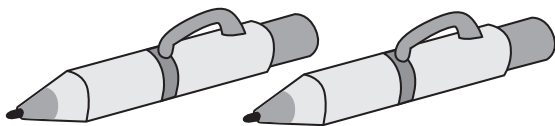

2. They're

\_\_\_\_\_

-----

\_\_\_\_\_

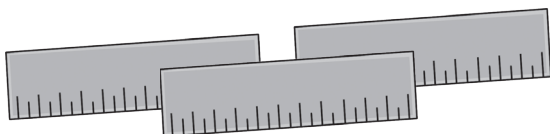

3. They're

\_\_\_\_\_

-----

\_\_\_\_\_

Name: \_\_\_\_\_

**A** Read, look, and number.

1. It's a notebook.
2. They're crayons.
3. They're scissors.
4. It's an eraser.

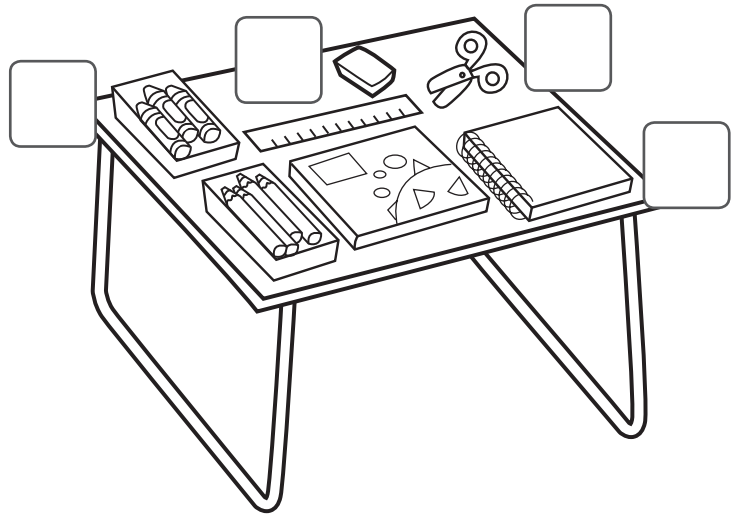

**B** Look at the pictures and circle the correct question.

chair desks

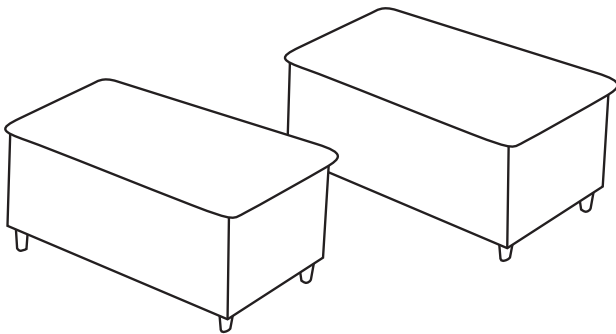

What is it? / What are they?

They're \_\_\_\_\_  
-----  
\_\_\_\_\_.

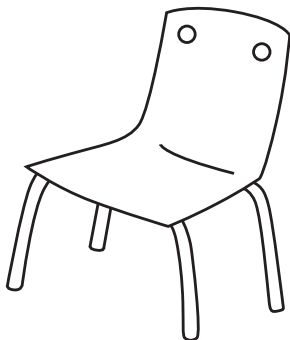

What is it? / What are they?

It's a \_\_\_\_\_  
-----  
\_\_\_\_\_.

● Answer the questions with words from the box.